

# Data Sheet



Article number: 03449055

Description: Fluro Heavy Duty Spherical Plain Bearing GE 55 SWE  
Hole Ø55

Note: 55

## Measures

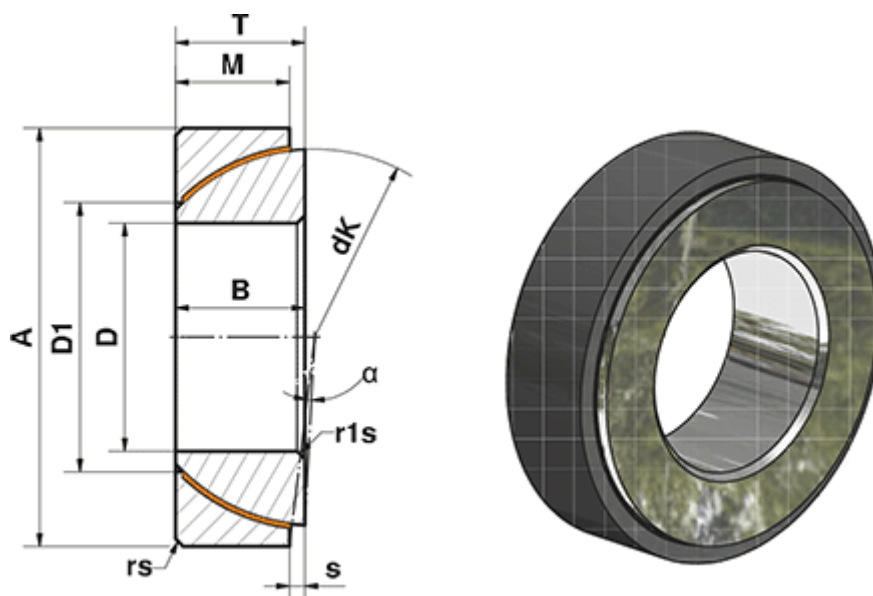

A	= 90	rs, r1s min	= 1
a (degrees)	= 4	S	= 5
B	= 23	Static load C0 (kN)	= 681
D	= 55	T	= 23
D1	= 62.7	Weight (g)	= 645
dK	= 82		
Dynamic load C (kN)	= 408		
M	= 20		